

A-A断面図

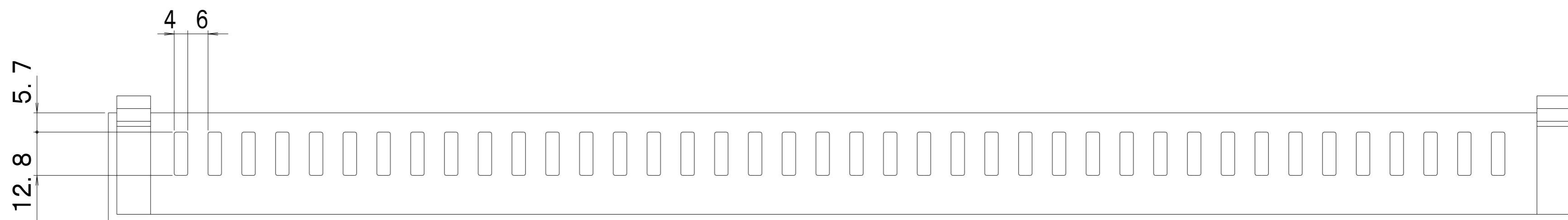

ZAA161-BA02 内窓プレス(手動開閉式)商品図

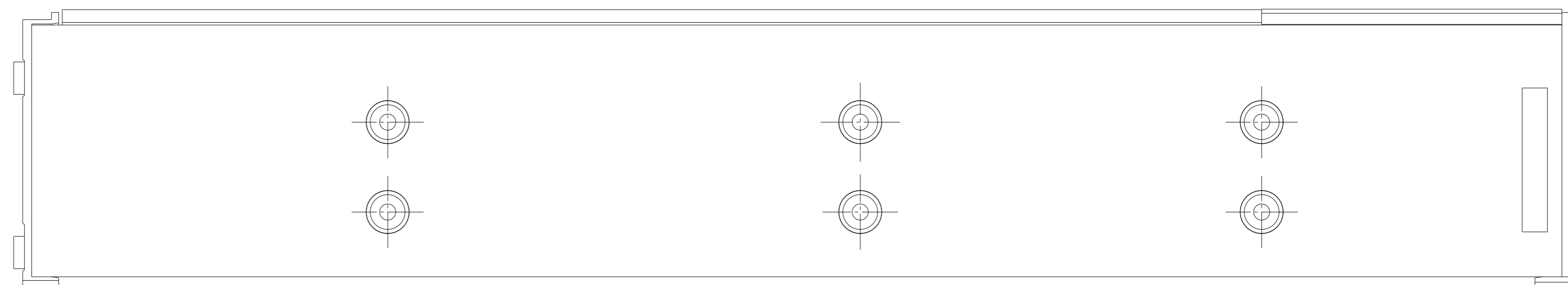
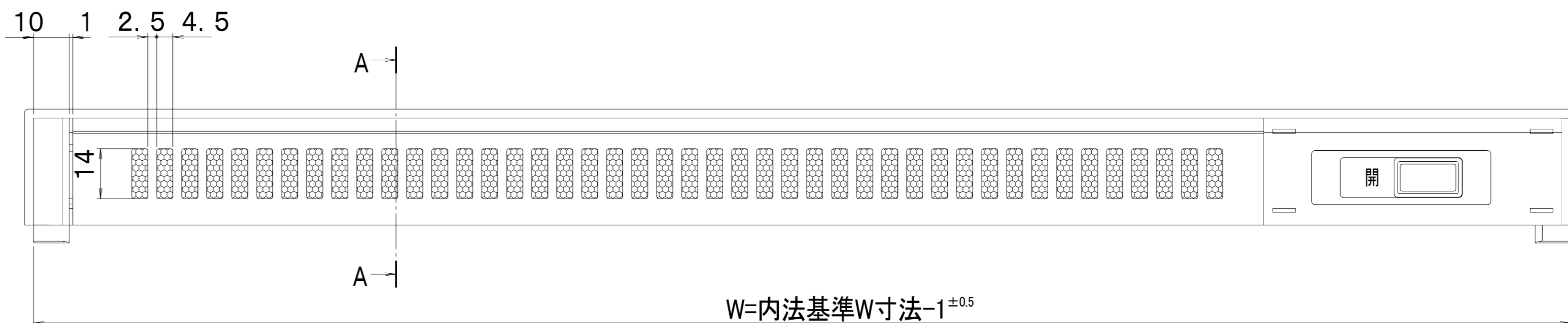
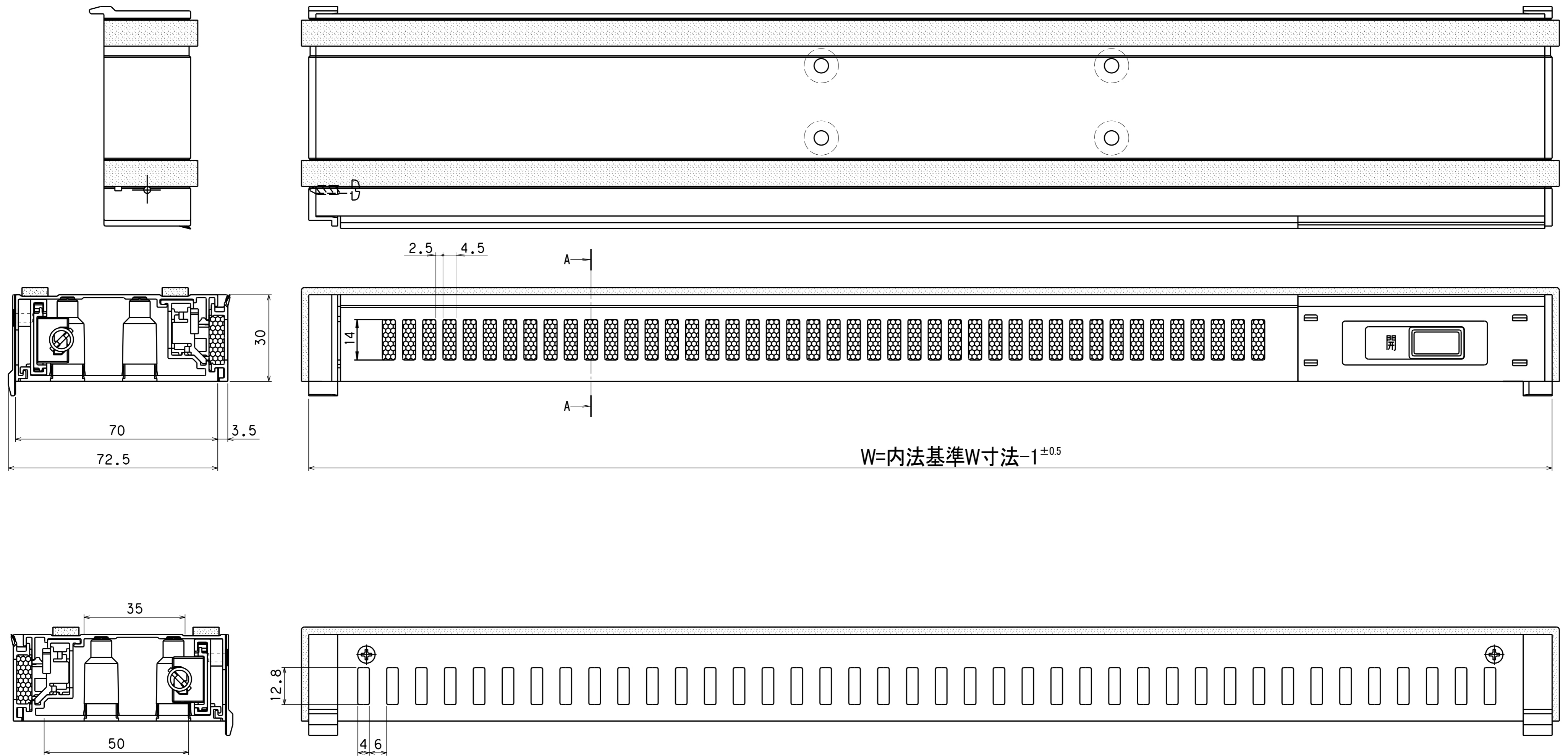

ZAA161-BA05 内窓プレス(温度感知式)商品図

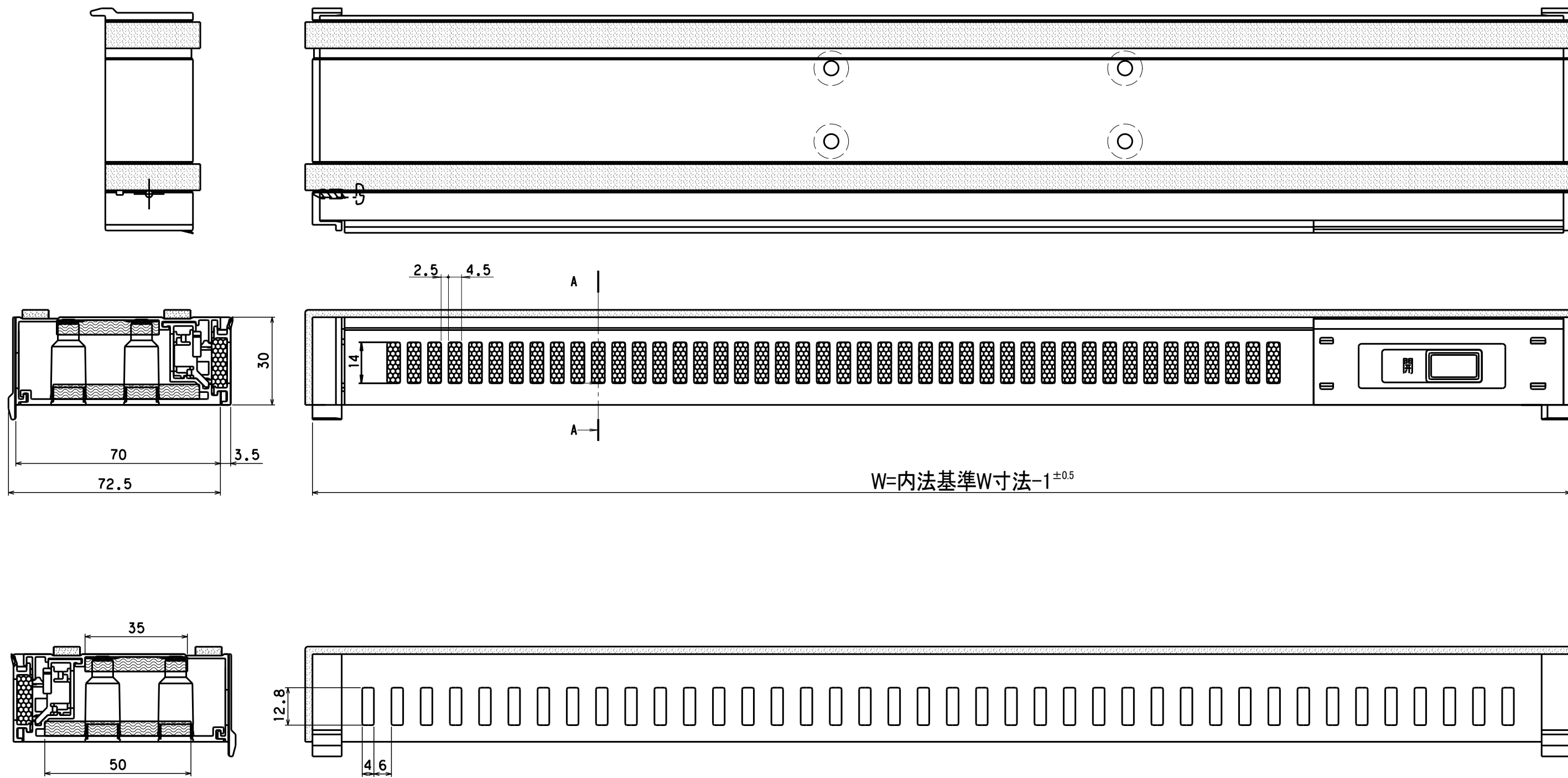

ZAA161-BA06 内窓プレス(手動開閉式・吸音式)商品図

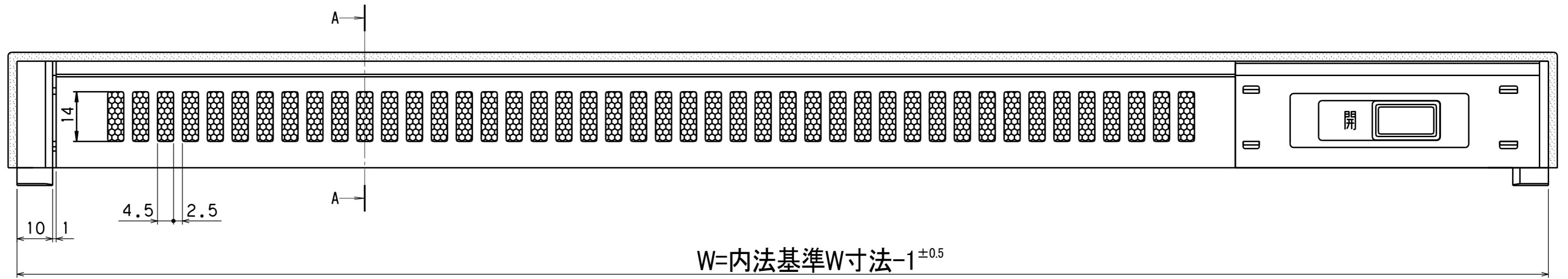
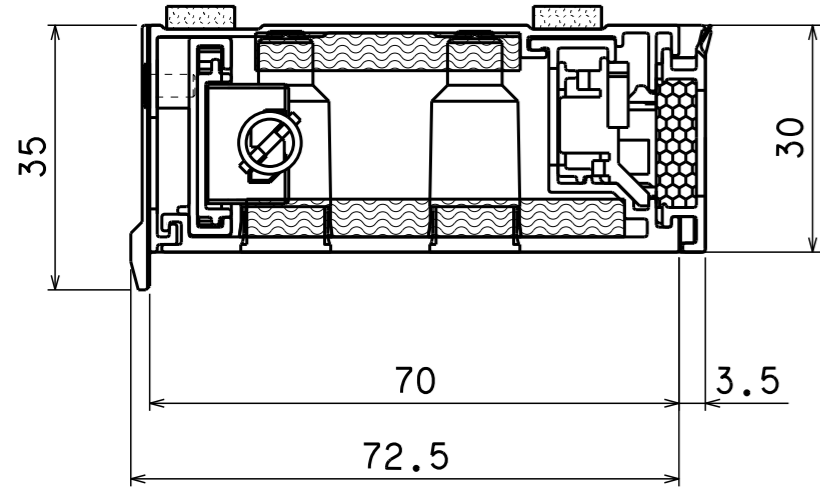
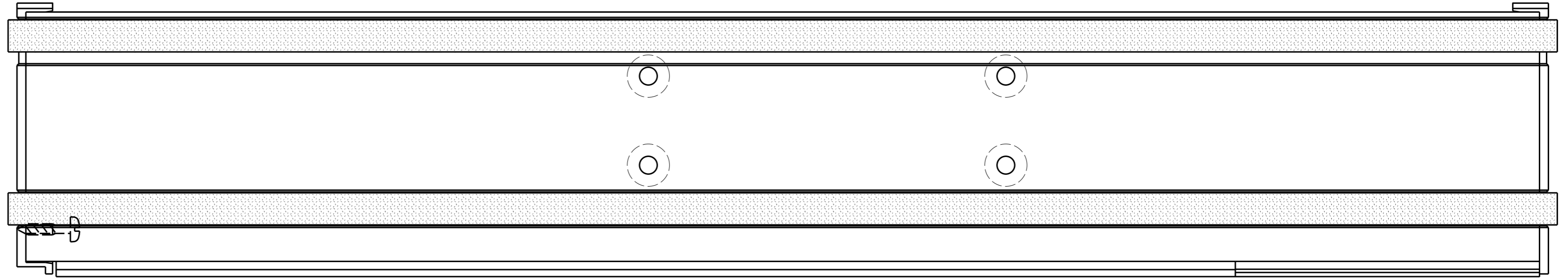
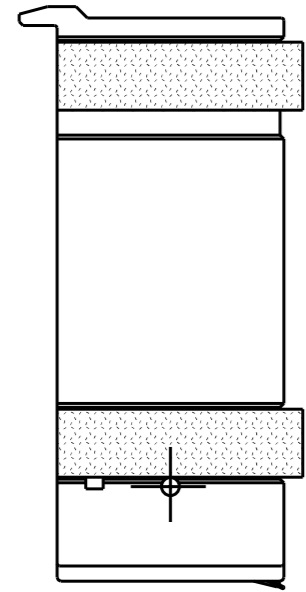

W=内法基準W寸法-1^{±0.5}

A-A断面図

